



F-clamp

2020

PRODUCT CATALOG

扬州福荣五金工具有限公司

YANGZHOU FURONG HARDWARE TOOL CO.,LTD.

扬州福荣五金工具有限公司

YANGZHOU FURONG HARDWARE TOOL CO.,LTD.

FURONG HARDWARE TOOL

[www.furongtools.com](http://www.furongtools.com)

地址：扬州西郊杨庙镇工业园区

电话：0086-514-87834886 87834885 87831286 87836058

传真：0086-514-87832490 邮编：225125

邮箱：sales@furongtools.com

网址：www.furongtools.com



福荣工具 得心应手



Professional  
achievement  
of the future

# CORPORATE PHILOSOPHY

## 企业理念

福荣人始终秉承“品质、诚信、服务、开拓”的企业理念，立足客户的个性化需求，为客户设计出高效、节能的高品质产品。

创新是根本，质量是生命，务实是宗旨，客户是效益，管理是未来。



扬州福荣五金工具有限公司

YANGZHOU FURONG HARDWARE TOOL CO.,LTD.

## Company Profile

### 公司简介



扬州福荣五金工具有限公司位于历史悠久的文化古城——扬州市，地理位置优越，交通方便，京沪、宁通高速、宁启铁路、扬泰机场近在咫尺。

本公司是国内专业生产木工夹系列产品的主要生产厂家之一。现已拥有大规模的技术力量和完善的质量控制体系来保障大规模的生产和提供高质量的产品，完善的售后服务更为工厂的快速发展奠定了坚实基础。

本公司恪守“信誉第一，顾客至上”的宗旨，广泛开拓市场，产品远销欧美等十几个国家和地区，时刻把握为广大客户服务的良机，并热忱欢迎海内外商界朋友与我公司携手共创未来。

Yangzhou Furong Hardware Tools Co., Ltd. is located in Yangzhou, a cultural city with a long history, with superior geographical location and convenient transportation. Beijing-Shanghai, Ningtong Expressway, Ningqi Railway, and Yangtai Airport are within easy reach.

The company is one of the main domestic manufacturers specializing in the production of woodworking clamps. Now we have a large-scale technical force and a complete quality control system to ensure large-scale production and provide high-quality products, and perfect after-sales service has laid a solid foundation for the rapid development of the factory.

The company adheres to the tenet of "reputation first, customer first", and expands the market extensively. The products are exported to more than a dozen countries and regions such as Europe and the United States. We always seize the opportunity to serve our customers. We warmly welcome business friends at home and abroad to join our company. Create a better future.

# 璀璨夺目的荣誉 DAZZLING GLORY

荣誉，印证了昨日的辉煌，记录了今日的收获，也确定了明日的起点。多年来，扬州福荣确立了以“追求卓越创一流，演绎时代精品；守法诚信人为本，构建绿色文明”为管理方针，企业多次荣获企业资质等级A级企业、诚信守法企业等荣誉。

Honor confirms yesterday's brilliance, records today's gains, and determines the starting point for tomorrow. Over the years, Yangzhou Furong has established the management policy of "pursuing excellence and creating first-class products, interpreting the best of the times; law-abiding and honest people-oriented, and building a green civilization". The company has won many honors such as corporate credit rating A-level enterprise and integrity and law-abiding enterprise.

## 企业荣誉 Enterprise honor

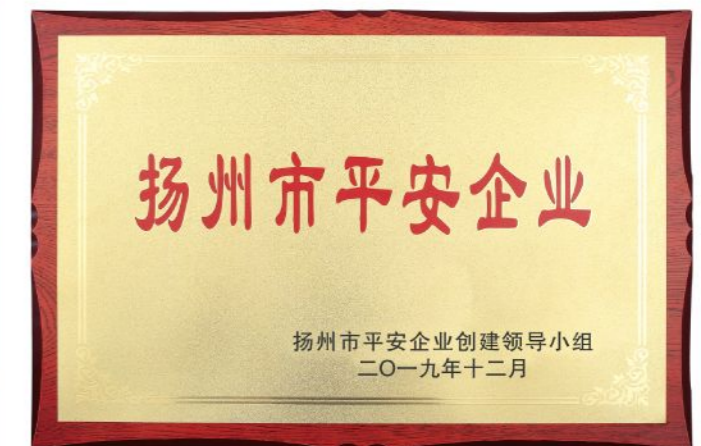

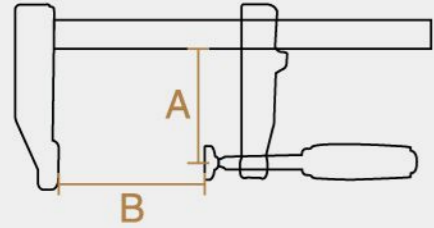

三星木工夹 Three star's clamp

货号 ART NO	品名规格A SPECIFIC (A × B)	净重kg N.W.(kg)	包装尺码 MEAS.(cm)	装箱数量 QTY
10001	50 × 100	19.5	40 × 28 × 20	50
10002	50 × 150	20.5	40 × 28 × 20	50
10003	50 × 200	21.5	40 × 28 × 20	50
10004	50 × 250	22.5	40 × 30 × 20	50
10005	50 × 300	23.5	40 × 30 × 20	50
20001	80 × 150	15.5	46 × 26 × 14	20
20002	80 × 200	16.5	46 × 26 × 14	20
20003	80 × 250	17.5	46 × 26 × 14	20
20004	80 × 300	18.5	46 × 29 × 14	20
20005	80 × 400	20	50 × 29 × 14	20
20006	80 × 500	21.5	60 × 29 × 14	20
30001	120 × 200	17.5	43 × 26 × 20.5	10
30002	120 × 250	18.5	43 × 26 × 20.5	10
30003	120 × 300	19.5	43 × 26 × 20.5	10
30004	120 × 400	21	56 × 20 × 20.5	10
30005	120 × 500	22.5	63 × 20 × 20.5	10
30006	120 × 600	24	73 × 20 × 20.5	10
30007	120 × 800	16	92 × 19.5 × 9.5	6
30008	120 × 1000	18	112 × 19.5 × 9.5	6
30009	120 × 1200	20	132 × 19.5 × 9.5	6
30010	120 × 1500	15.5	162 × 19.5 × 9.5	4
30011	120 × 2000	19.5	212 × 19.5 × 9.5	4

**Features**

1. The service life of ductile iron clamp arm is more than twice that of ordinary castings.
2. The unique locking block design makes the movement smoother and the locking firmer.
3. The PP+TPR two-color handle design is more ergonomic, and the grip is more comfortable.
4. The 45# steel rail has greater clamping force and longer service life.

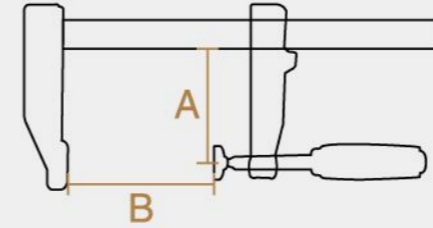

线条木工夹 Wood clamp

货号 ART NO	品名规格A SPECIFIC (A × B)	净重kg N.W.(kg)	包装尺码 MEAS.(cm)	装箱数量 QTY
40001	50 × 100	19.5	40 × 28 × 20	50
40002	50 × 150	20.5	40 × 28 × 20	50
40003	50 × 200	21.5	40 × 28 × 20	50
40004	50 × 250	22.5	40 × 30 × 20	50
40005	50 × 300	23.5	40 × 30 × 20	50
50001	80 × 150	15.5	46 × 26 × 14	20
50002	80 × 200	16.5	46 × 26 × 14	20
50003	80 × 250	17.5	46 × 26 × 14	20
50004	80 × 300	18.5	46 × 29 × 14	20
50005	80 × 400	20	50 × 29 × 14	20
50006	80 × 500	21.5	60 × 29 × 14	20
60001	120 × 200	17.5	43 × 26 × 20.5	10
60002	120 × 250	18.5	43 × 26 × 20.5	10
60003	120 × 300	19.5	43 × 26 × 20.5	10
60004	120 × 400	21	56 × 20 × 20.5	10
60005	120 × 500	22.5	63 × 20 × 20.5	10
60006	120 × 600	24	73 × 20 × 20.5	10
60007	120 × 800	16	92 × 19.5 × 9.5	6
60008	120 × 1000	18	112 × 19.5 × 9.5	6
60009	120 × 1200	20	132 × 19.5 × 9.5	6
60010	120 × 1500	15.5	162 × 19.5 × 9.5	4
60011	120 × 2000	19.5	212 × 19.5 × 9.5	4

**Features**

1. The service life of ductile iron clamp arm is more than twice that of ordinary castings.
2. The unique locking block design makes the movement smoother and the locking firmer.
3. The PP+TPR two-color handle design is more ergonomic, and the grip is more comfortable.
4. The 45# steel rail has greater clamping force and longer service life.

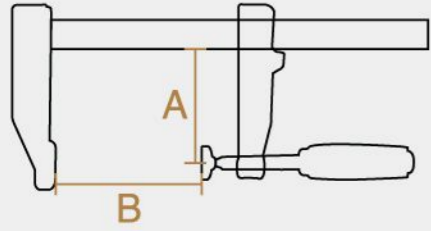

塑柄木工夹 Wood clamp, plastic handle

货号 ART NO	品名规格 SPECIFIC (A x B)	净重kg N.W.(kg)	包装尺码 MEAS.(cm)	装箱数量 QTY
70001	50 x 100	15.5	38 x 24 x 19	50
70002	50 x 150	16.5	40 x 24 x 19	50
70003	50 x 200	18	38 x 27 x 19	50
70004	50 x 250	19.5	38 x 29 x 19	50
70005	50 x 300	21	38 x 30 x 19	50
70006	50 x 400	23.5	48 x 30 x 19	50
70007	60 x 100	11.5	37.5 x 30 x 11	30
70008	60 x 150	12.5	37.5 x 34 x 11	30
70009	60 x 200	13.5	37.5 x 34 x 11	30
70010	60 x 250	14.5	37.5 x 37 x 11	30
70011	60 x 300	15.5	41 x 37 x 11	30
70012	60 x 400	17	51 x 37 x 11	30
70013	60 x 500	18	61 x 37 x 11	30
80001	80 x 150	14	44 x 27 x 13.5	20
80002	80 x 200	15	44 x 27 x 13.5	20
80003	80 x 250	16	44 x 27 x 13.5	20
80004	80 x 300	17	44 x 28 x 13.5	20
80005	80 x 400	18	50 x 28 x 13.5	20
80006	80 x 500	20.5	60 x 28 x 13.5	20
80007	100 x 200	18	43 x 29 x 16.5	20
80008	100 x 250	19	43 x 29 x 16.5	20
80009	100 x 300	20	43 x 28 x 16.5	20
80010	100 x 400	22.5	49 x 29 x 16.5	20
80011	100 x 500	12	58 x 15 x 14	10
80012	100 x 600	13	68 x 15 x 14	10
80013	100 x 800	15	88 x 15 x 14	10
80014	100 x 1000	17	108 x 15 x 14	10
90001	120 x 200	15.5	53 x 18.5 x 13	10
90002	120 x 250	16.5	53 x 18.5 x 14	10
90003	120 x 300	17	53 x 18.5 x 14	10
90004	120 x 400	19	53 x 18.5 x 16	10
90005	120 x 500	20.5	60 x 18.5 x 16	10
90006	120 x 600	22	70 x 18.5 x 16	10
90007	120 x 800	15.5	90 x 18.5 x 10	6
90008	120 x 1000	17	110 x 18.5 x 10	6
90009	120 x 1200	19	130 x 18.5 x 10	6
90010	120 x 1500	15	160.5 x 18.5 x 7	4
90011	120 x 2000	18.5	210.5 x 18.5 x 7	4

Features

The PP+TPR two-color handle design is more ergonomic, and the grip is more comfortable.

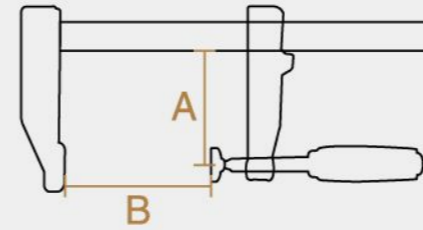

意式木工夹 Wood clamp, Italy type

货号 ART NO	品名规格 SOECIFI (A x B)	净重kg N.W.(kg)	包装尺码 MEAS.(cm)	装箱数量 QTY
34001	25 x 6 x 150	8	30.5 x 13 x 12	10
34002	25 x 6 x 200	8.5	30.5 x 13 x 12.5	10
34003	25 x 6 x 250	9	35 x 13 x 12.5	10
34004	25 x 6 x 300	9.5	40 x 13 x 12.5	10
34005	25 x 6 x 350	10	45 x 13 x 12.5	10
34006	30 x 6 x 300	11	41 x 13.5 x 11.5	10
34007	30 x 6 x 350	11.5	46 x 13.5 x 11.5	10
34008	30 x 6 x 400	12	51 x 13.5 x 11.5	10
34009	30 x 6 x 500	13.5	61 x 13.5 x 11.5	10
34010	35 x 7 x 500	20.5	61.5 x 18 x 15	10
34011	35 x 7 x 600	13	71.5 x 18 x 8	6
34012	35 x 7 x 700	14.5	81.5 x 18 x 8	6
34013	35 x 7 x 800	16	91.5 x 18 x 8	6
34014	40 x 7 x 1000	19	112.5 x 19 x 9	6
34015	40 x 7 x 1200	22.5	132.5 x 19 x 9	6
34016	40 x 7 x 1500	27	162.5 x 19 x 9	6
34017	40 x 7 x 2000	35	212.5 x 19 x 9	6

Features

The overall forging forming is more durable.

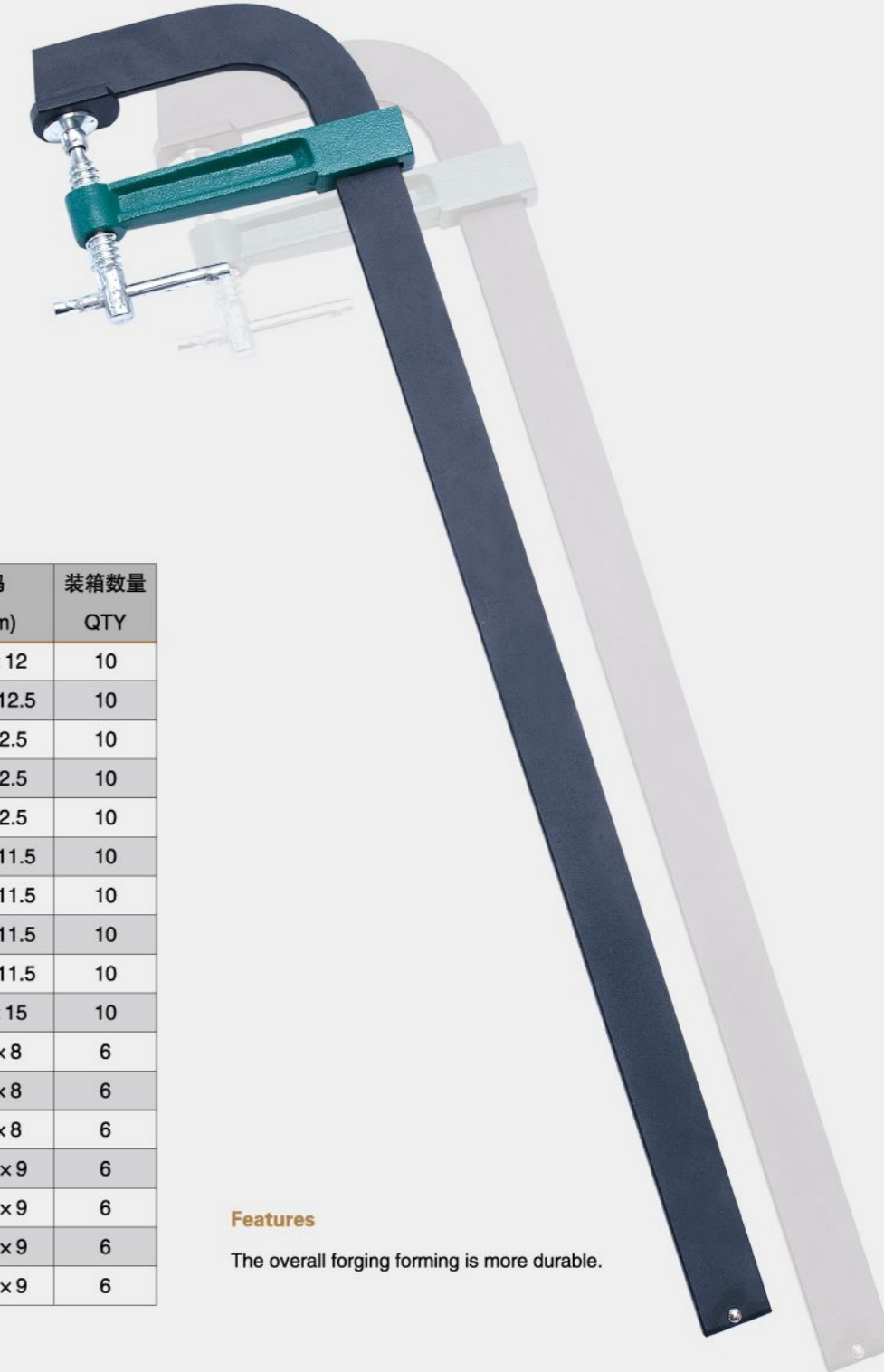

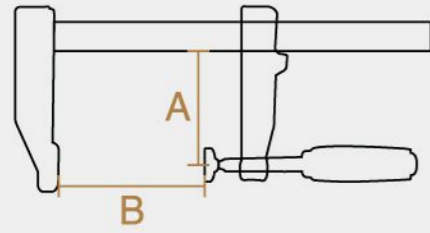

T ü V/GS木工夹 T ü V/GS Wood clamp

货号 ART NO	品名规格A SPECIFIC (A × B)	净重kg N.W.(kg)	包装尺码 MEAS.(cm)	装箱数量 QTY
17001	50 × 100	15.5	38 × 24 × 18	50
17002	50 × 150	16.5	40 × 24 × 18	50
17003	50 × 200	18	38 × 27 × 18	50
17004	50 × 250	19.5	38 × 29 × 18	50
17005	50 × 300	21	38 × 30 × 18	50
17006	50 × 400	23.5	48 × 30 × 18	50
17007	60 × 100	11.5	36.5 × 30 × 11	30
17008	60 × 150	12.5	36.5 × 34 × 11	30
17009	60 × 200	13.5	36.5 × 34 × 11	30
17010	60 × 250	14.5	37 × 36 × 11	30
17011	60 × 300	15.5	41 × 37 × 11	30
17012	60 × 400	17	51 × 37 × 11	30
17013	60 × 500	18	61 × 37 × 11	30
18001	80 × 150	14	44 × 27 × 13.5	20
18002	80 × 200	15	44 × 27 × 13.5	20
18003	80 × 250	16	44 × 27 × 13.5	20
18004	80 × 300	17	44 × 28 × 13.5	20
18005	80 × 400	18	50 × 28 × 13.5	20
18006	80 × 500	20.5	60 × 28 × 13.5	20
18007	100 × 200	18	43 × 29 × 16.5	20
18008	100 × 250	19	43 × 29 × 16.5	20
18009	100 × 300	20	43 × 28 × 16.5	20
18010	100 × 400	22.5	49 × 29 × 16.5	20
18011	100 × 500	12	58 × 15 × 14	10
18012	100 × 600	13	68 × 15 × 14	10
18013	100 × 800	15	88 × 15 × 14	10
18014	100 × 1000	17	108 × 15 × 14	10
19001	120 × 200	15.5	52 × 18.5 × 12.5	10
19002	120 × 250	16.5	52 × 18.5 × 13.5	10
19003	120 × 300	17	52 × 18.5 × 13.5	10
19004	120 × 400	19	52 × 18.5 × 13.5	10
19005	120 × 500	20.5	60 × 18.5 × 15.5	10
19006	120 × 600	22	70 × 18.5 × 15.5	10
19007	120 × 800	15.5	90 × 18.5 × 10	6
19008	120 × 1000	17	110 × 18.5 × 10	6
19009	120 × 1200	19	130 × 18.5 × 10	6
19010	120 × 1500	15	160 × 18.5 × 6.5	4
19011	120 × 2000	18.5	210 × 18.5 × 6.5	4

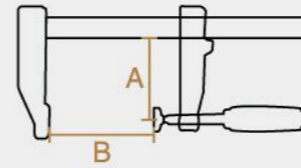

T ü V/GS木工夹140(8 × 30) T ü V/GS Wood clamp

货号 ART NO	品名规格A SPECIFIC (A × B)	净重kg N.W.(kg)	包装尺码 MEAS.(cm)	装箱数量 QTY
22001	140 × 200	16.5	51 × 20.5 × 13.5	10
22002	140 × 250	17.5	51 × 20.5 × 14.5	10
22003	140 × 300	18	51 × 20.5 × 14.5	10
22004	140 × 400	20	51 × 20.5 × 16.5	10
22005	140 × 500	21	60 × 20.5 × 16.5	10
22006	140 × 600	23	70 × 20.5 × 16.5	10
22007	140 × 800	16	90 × 20.5 × 10.5	6
22008	140 × 1000	18.5	110 × 20.5 × 10.5	6
22009	140 × 1200	19.5	130 × 20.5 × 10.5	6
22010	140 × 1500	15	160 × 20.5 × 7	4
22011	140 × 2000	19	210 × 20.5 × 7	4

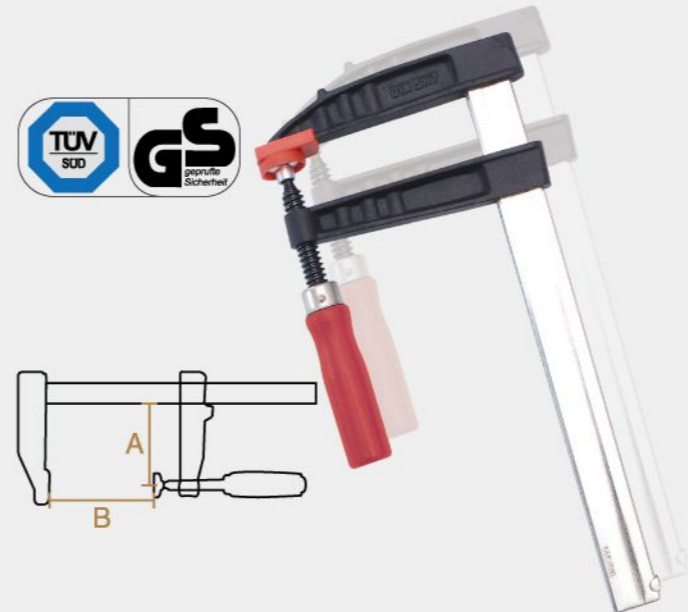

T ü V/GS重型木工夹120(11 × 35) T ü V/GS Wood clamp

货号 ART NO	品名规格A SPECIFIC (A × B)	净重kg N.W.(kg)	包装尺码 MEAS.(cm)	装箱数量 QTY
21001	120 × 500	30	62 × 18.5 × 17	10
21002	120 × 600	19	72 × 18.5 × 10.5	6
21003	120 × 800	22.5	92 × 18.5 × 10.5	6
21004	120 × 1000	26	112 × 18.5 × 10.5	6
21005	120 × 1200	30	137 × 18.5 × 10.5	6

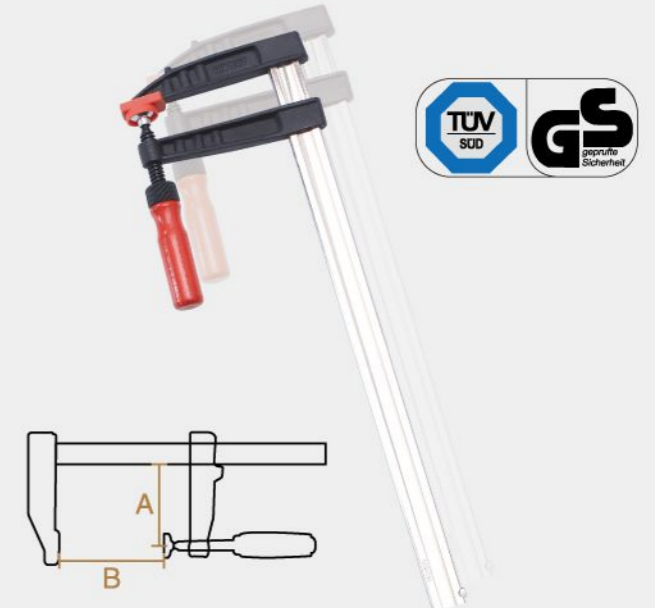

T ü V/GS木工夹140(9 × 35) T ü V/GS Wood clamp

货号 ART NO	品名规格A SPECIFIC (A × B)	净重kg N.W.(kg)	包装尺码 MEAS.(cm)	装箱数量 QTY
23001	140 × 200	18.5	58 × 22 × 14.5	10
23002	140 × 250	19.5	58 × 22 × 14.5	10
23003	140 × 300	20.5	58 × 22 × 14.5	10
23004	140 × 400	22.5	58 × 22 × 16	10
23005	140 × 500	24.5	63 × 22 × 17.5	10
23006	140 × 600	16	73 × 22 × 10	10
23007	140 × 800	18.5	93 × 22 × 10	6
23008	140 × 1000	21	113 × 22 × 10	6
23009	140 × 1200	23.5	133 × 22 × 10	6
23010	140 × 1500	27.5	163 × 22 × 10	6
23011	140 × 2000	34	213 × 22 × 10	6

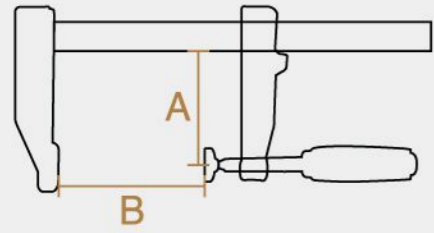

木工夹A型 Wood clamp

货号 ART NO	品名规格A SPECIFIC (A×B)	净重kg N.W.(kg)	包装尺码 MEAS.(cm)	装箱数量 QTY
25001	50×100	14	32×22×19	50
25002	50×150	15	32×23×19	50
25003	50×200	16	32×27×18	50
25004	50×250	17.5	32×31×18	50
25005	50×300	19	37×30×18	50
25006	50×400	22	47×30×18	50
25007	60×100	20.5	33×23×21.5	50
25008	60×150	22.5	33×23×21.5	50
25009	60×200	24.5	33×29×21.5	50
25010	60×250	26	33×31×21.5	50
25011	60×300	28	38×31×21.5	50
25012	60×400	30	48×30×21.5	50
26001	80×150	16	41×29×13	30
26002	80×200	17.5	43×31×13	30
26003	80×250	18	43×35×13	30
26004	80×300	19.5	43×38×13	30
26005	80×400	22	49×38×13	30
26006	80×500	24.5	50×37×18	30
26007	80×600	25	69×37×13	30
26008	100×200	14.5	45×23×16	20
26009	100×250	15.5	45×23×16	20
26010	100×300	16	45×23×16	20
26011	100×400	18	50×26×16	20
26012	100×500	10	60×16×13	10
26013	100×600	11	70×16×13	10
26014	100×800	13	90×16×13	10
26015	100×1000	14.5	110×16×13	10
27001	120×200	23	46×28×18	20
27002	120×250	24	48×28×18	20
27003	120×300	26	48×28×18	20
27004	120×350	26.5	50×28×18	20
27005	120×400	28	51×30×18	20
27006	120×450	15	56×18×15	10
27007	120×500	15.5	61×18×15	10
27008	120×600	17	71×18×15	10
27009	120×700	18.5	81×18×15	10
27010	120×800	12	91×18×8.5	6
27011	120×900	12.5	101×18×8.5	6
27012	120×1000	13.5	111×18×8.5	6
27013	120×1200	15	131×18×8.5	6
27014	120×1500	17.5	161×18×8.5	6
27015	120×2000	22	211×18×8.5	6

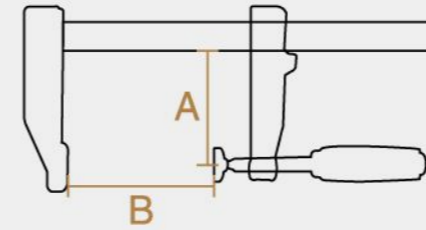

木工夹B型 Wood clamp

货号 ART NO	品名规格A SPECIFIC (A×B)	净重kg N.W.(kg)	包装尺码 MEAS.(cm)	装箱数量 QTY
29001	50×100	12	32×22×17	50
29002	50×150	15.5	32×23×18	50
29003	50×200	14	32×27×17	50
29004	50×250	15	32×30×17	50
29005	50×300	16	37×26×17	50
29006	50×400	18	47×26×17	50
31001	80×150	13	40×29×12	30
31002	80×200	14.5	42×31×12	30
31003	80×250	15.5	42×31×12	30
31004	80×300	16.5	42×38×12	30
31005	80×400	18	48×38×12	30
31006	80×500	20.5	50×40×12	30
32001	120×200	17	46×24×18	20
32002	120×250	18	46×24×18	20
32003	120×300	19	46×26×18	20
32004	120×350	20	50×26×18	20
32005	120×400	21	50×26×18	20
32006	120×450	11	55×18×13	10
32007	120×500	11.5	60×18×13	10
32008	120×600	12.5	70×18×13	10
32009	120×700	13.5	80×18×13	10
32010	120×800	9	90×18×8	6
32011	120×900	9.5	100×18×8	6
32012	120×1000	10	110×18×8	6
32013	120×1200	11	130×18×8	6
32014	120×1500	13	160×18×8	6
32015	120×2000	16	210×18×8	6





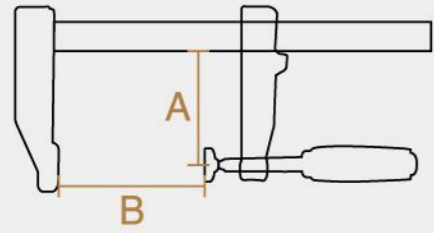

美式木工夹 Wood clamp, American type

货号 ART NO	品名规格A SPECIFIC (A×B)	净重kg N.W.(kg)	包装尺码 MEAS.(cm)	装箱数量 QTY
38001	60×100 4"	16	42×22×10	30
38002	60×150 6"	17	42×22×10	30
38003	60×200 8"	18	42×31×10.5	30
38004	60×250 10"	19.5	42×37×10.5	30
38005	60×300 12"	20.5	42×40×10.5	30
38006	60×400 16"	15	50×28.5×10.5	20
38007	60×450 18"	16	55×28.5×10.5	20
38008	60×600 24"	18.5	70×28.5×10.5	20
38009	60×750 30"	21	82×28.5×10.5	20
38010	60×900 36"	11	100×14.5×10.5	10
38011	60×1200 48"	14.5	130×14.5×10.5	10
39001	90×150 6"	22	42×30×18.5	24
39002	90×200 8"	23	42×30×18.5	24
39003	90×250 10"	24	42×30×18.5	24
39004	90×300 12"	25.5	42×30×21	24
39005	90×400 16"	26	52×30×21	24
39006	90×450 18"	29	57×30×21	24
39007	90×500 20"	15	62×30×21	12
39008	90×600 24"	16	72×30×21	12
39009	90×750 30"	18	87×30×21	12
39010	90×800 32"	19	92×30×21	12
39011	90×900 36"	20	102×30×21	12
39012	90×1000 40"	21	112×30×21	12
41001	120×250	28.5	45×34×18	20
41002	120×300	31	45×34×18	20
41003	120×500	19	63.5×18×17.5	10
41004	120×600	20	73.5×18×17.5	10
41005	120×800	14	93.5×18×17.5	6
41006	120×1000	16	113.5×18×17.5	6
41007	120×1200	17	133.5×18×17.5	6

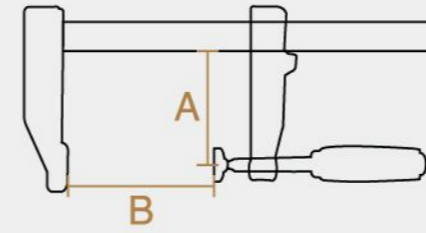

英式木工夹 Wood clamp, British type

货号 ART NO	品名规格A SPECIFIC (A×B)	净重kg N.W.(kg)	包装尺码 MEAS.(cm)	装箱数量 QTY
35001	50×100	14	26.5×22×17.5	50
35002	50×150	15.5	28.5×23×17.5	50
35003	50×200	16.5	28.5×27×17	50
35004	50×250	18	32×28×17	50
35005	50×300	19	37×28×17	50
35006	50×400	20	47×28×17	50
36001	80×150	15.5	41×29×13	30
36002	80×200	17	43×21×13	30
36003	80×250	18	43×35×13	30
36004	80×300	19	43×38×13	30
36005	80×400	21.5	48×38×13	30
36006	80×500	24	58×37×13	30
36007	80×600	26	68×37×13	30
37001	120×200	25.5	46×28×18	20
37002	120×250	27	46×28×18	20
37003	120×300	28	46×28×18	20
37004	120×350	29	50×28×18	20
37005	120×400	15.5	50×18×15	10
37006	120×450	16	55×18×15	10
37007	120×500	17	60.5×18×15	10
37008	120×600	18	70.5×18×15	10
37009	120×700	19.5	80.5×18×15	10
37010	120×800	12.5	90.5×18×8.5	6
37011	120×900	13.5	100.5×18×8.5	6
37012	120×1000	14.5	110.5×18×8.5	6
37013	120×1200	15	130.5×18×8.5	6
37014	120×1500	18.5	160.5×18×8.5	6
37015	120×2000	22.5	210.5×18×8.5	6



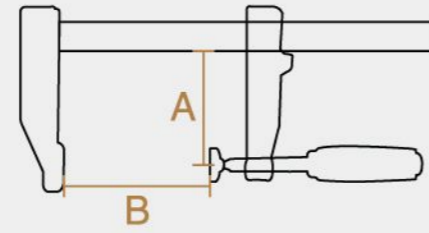

泵夹 Pump clamp

货号 ART NO	品名规格A SPECIFIC (A x B)	净重kg N.W.(kg)	包装尺码 MEAS.(cm)	装箱数量 QTY
42001	120 x 500	17	61 x 18 x 15	10
42002	120 x 1000	15	111 x 18 x 9	6
42003	120 x 2000	23	211 x 18 x 9	6

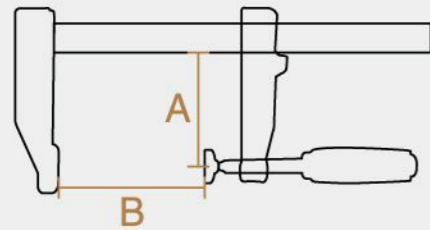

六角泵夹 Six angle's Pump clamp

货号 ART NO	品名规格A SPECIFIC (A x B)	净重kg N.W.(kg)	包装尺码 MEAS.(cm)	装箱数量 QTY
44001	120 x 200	8	43 x 20.5 x 9	4
44002	120 x 250	8.5	43 x 20.5 x 9	4
44003	120 x 300	9	43 x 20.5 x 9	4
44004	120 x 400	10	53 x 20.5 x 9	4
44005	120 x 500	10.5	63 x 20.5 x 9	4
44006	120 x 600	11.5	73 x 20.5 x 9	4
44007	120 x 800	13	93 x 20.5 x 9	4
44008	120 x 1000	14.5	113 x 20.5 x 9	4
44009	120 x 1200	16.5	133 x 20.5 x 9	4
44010	120 x 1500	19	163 x 20.5 x 9	4

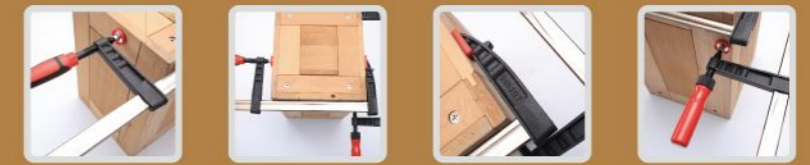

美式G字夹 G clamp, American type

货号 ART NO	品名规格A SPECIFIC	净重kg N.W.(kg)	包装尺码 MEAS.(cm)	装箱数量 QTY
47001	1 "	10	32 x 25 x 11	144
47002	2 "	29.5	35.5 x 23.5 x 21.5	144
47003	3 "	31	52 x 19 x 21	48
47004	4 "	31	39.5 x 23 x 23	36
47005	5 "	23	27 x 26 x 25	24
47006	6 "	30	30 x 28 x 26	24
47007	8 "	22	37 x 33 x 15.5	12
47008	10 "	29	42 x 35 x 17	12
47009	12 "	18	47 x 18 x 18	6

弹簧压力器 Spring compressors

货号 ART NO	品名规格A SPECIFIC	净重kg N.W.(kg)	包装尺码 MEAS.(cm)	装箱数量 QTY	形式 FORM
52001	弹簧压力器	24	36 x 26 x 22	12套	空心
53001	弹簧压力器	24	36 x 26 x 22	12套	实心



**RATCHET PIPE THREADING KIT, TYPE 62B**

Item No.	Specs	Qty/Ctn	G.W./N.W.	Carton Size
	inch			
55001	1/2 " ,3/4 " ,1 "	4	19/18	37.5 x 32.5 x 23.5



**RATCHET PIPE THREADING KIT, TYPE 62B**

Item No.	Specs	Qty/Ctn	G.W./N.W.	Carton Size
	inch			
56001	1/2 " ,3/4 " ,1 " ,1 1/4 "	4	20/19	42 x 40 x 23.5



**RATCHET PIPE THREADING KIT, TYPE 62B**

Item No.	Specs	Qty/Ctn	G.W./N.W.	Carton Size
	inch			
57001	3/8 " ,1/2 " ,3/4 " ,1 " ,1 1/4 "	4	22/21	42 x 40 x 23.5
57002	1/4 " ,3/8 " ,1/2 " ,3/4 " ,1 " ,1 1/4 "	4	24.5/23.5	42 x 40 x 23.5



**DIE HESDS,.. TYPE 62B**

Item No.	Specs	Qty/Ctn	G.W./N.W.	Carton Size
	inch			
58001	1/4 "	20	12/11	40 x 16.5 x 17
58002	3/8 "	20	11/10	40 x 16.5 x 17
58003	1/2 "	20	13/12.5	40 x 16.5 x 17
58004	3/4 "	20	13.5/13	40 x 16.5 x 17
58005	1 "	20	17/16	45.5 x 19 x 19
58006	1 1/4 "	20	17.5/17	50 x 21 x 21



**RATCHET PIPE THREADING KIT, TYPE 62B**

Item No.	Specs	Qty/Ctn	G.W./N.W.	Carton Size
	inch			
59001	1/2 " ,3/4 " ,1 " ,1 1/4 "	4	11.5/11	38 x 37 x 33.5
59002	3/8 " ,1/2 " ,3/4 " ,1 " ,1 1/4 "	4	13.5/13	38 x 37 x 33.5
59003	1/4 " ,3/8 " ,1/2 " ,3/4 " ,1 " ,1 1/4 "	4	16/15.5	38 x 37 x 33.5
Die bracket: malleable casting				
Die head cap: steel				



**RATCHET PIPE THREADING KIT, TYPE 62B**

Item No.	Specs	Qty/Ctn	G.W./N.W.	Carton Size
	inch			
59001C	1/2 " ,3/4 " ,1 " ,1 1/4 "	4	11.5/11	38 x 37 x 33.5
59002C	3/8 " ,1/2 " ,3/4 " ,1 " ,1 1/4 "	4	13.5/13	38 x 37 x 33.5
59003C	1/4 " ,3/8 " ,1/2 " ,3/4 " ,1 " ,1 1/4 "	4	16/15.5	38 x 37 x 33.5
Die bracket: malleable casting				
Die head cap: aluminium alloy				



**DIES**

Item No.	Specs	Qty/Ctn	G.W./N.W.	Carton Size
	inch			
70001	1/4 "	100	8/7.5	39.5 x 23 x 11
70002	3/8 "	100	8/7.5	39.5 x 23 x 11
70003	1/2 "	100	8.5/8	39.5 x 23 x 11
70004	3/4 "	100	8.5/8	39.5 x 23 x 11
70005	1 "	100	14/13.5	39.5 x 23 x 11
70006	1 1/4 "	100	15/14.5	39.5 x 23 x 11
70007	1 1/2 "	100	15/14.5	39.5 x 23 x 11
70008	2 "	100	25.5/25	39.5 x 23 x 11



**RATCHET PIPE THREADING KIT, TYPE-63**

Item No.	Specs	Qty/Ctn	G.W./N.W.	Carton Size
	inch			
73001	1/2 " ,3/4 " ,1 " ,1 1/4 " ,1 1/2 " ,2 "	2	24/23	52 x 25 x 35
73002	3/8 " ,1/2 " ,3/4 " ,1 " ,1 1/4 " ,1 1/2 " ,2 "	2	25/24	52 x 25 x 35
Die bracket: malleable casting				
Die head cap: 3/8 " - 1 1/4 " aluminium alloy and black finished				
1 1/2 " - 2 " aluminium alloy				



**RATCHET PIPE THREADING KIT, TYPE B**

Item No.	Specs	Qty/Ctn	G.W./N.W.	Carton Size
	inch			
75001	13pcs	2	20/19	48.5 x 26 x 37
Die head: 1/4 " ,3/8 " ,1/2 " ,3/4 " ,1 " ,1 1/4 "				
Water pump plier 10 " , pipe cutter No.2 10-60mm				
Beent nose pipe wrench 1 " , teflon tape 0.1 x 26mm20m				



# SALES NETWORK

销售网络



# EXCELLENT PRODUCTS

## 精益求精 缔造一流产品

Manufacturing advanced high quality products  
Client First,keep improving

# FURONG HARDWARE TOOL

